

# 800 SYSTEM

## VSP 828

7" VIDEO HANDS-FREE COLOR TFT MONITOR

### USER MANUAL



- Please read this manual carefully before using the product you purchase, and keep it well for future use.
- Please note that images and sketch maps in this manual may be different from the actual product.

## PRECAUTIONS

- Slots or openings in the back of the monitor are provided for ventilation and to ensure reliable operation of the video monitor or equipment and to protect it from overheating. These openings must not be blocked or covered. The monitor should never be placed near or over a radiator or heat register and should not be placed in a built-in installation such as a bookcase unless proper ventilation is provided.
- All parts should be protected from violence vibration. And not allow be impacting, knocking and dropping.
- For clean the LCD screen, using hands or wet cloth is forbidden.
- Please do the cleanness with soft cotton cloth; please do not use the organic or chemical detergent. If necessary, please use pure water or dilute soap water to clean the dust.
- Image distortion may occur if the video door phone is mounted too close to magnetic field e. g. Microwaves, TV, computers, etc.
- Please keep away the video door monitor from wet, high temperature, dust, and caustic and oxidation gas in order to avoid any unpredictable damage.
- Do not open the device in any condition, call the administrator for help if there is any problem.

## CONTENTS

Front panel.....	4
Mounting .....	5
Screen .....	6
Answering a call.....	7
Adjusting screen & volume.....	9
Door release .....	10
Calling other monitors.....	10
Monitoring .....	11
Opening staircase light.....	12
Monitor settings.....	13
Ring setting .....	14
Changing the display language.....	14
Restoring to default setting.....	15
Entering installer setup .....	15
Screen calibration .....	19
Specification.....	19

## Front panel

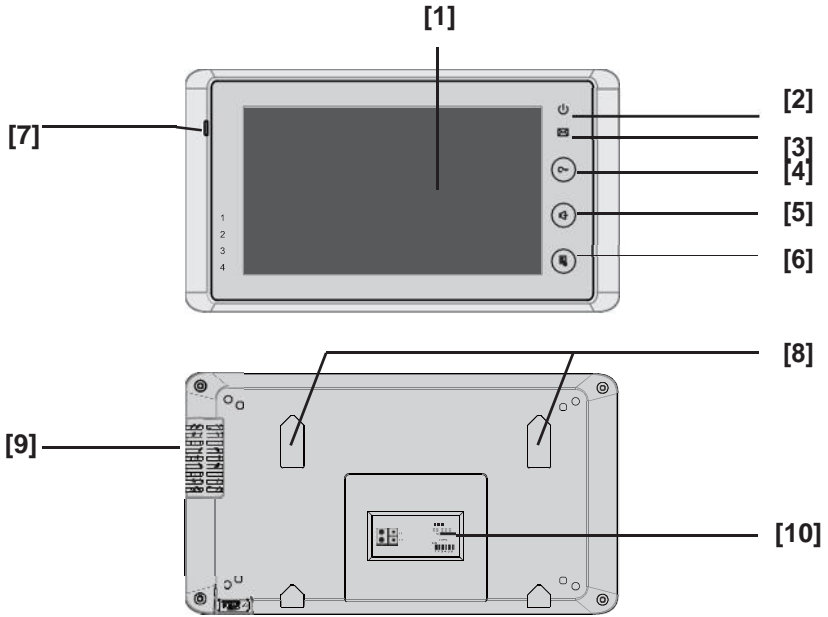

## Key functions

NO.	Item	Description
[1]	Digital LCD touch screen	<ul style="list-style-type: none"> <li>• See the next page for details</li> <li>• Display the visitors' image</li> </ul>
[2]	Power indicator	Light up when the monitor power-on
[3]	Message indicator	Light up when the monitor has missed call
[4]	Unlock button	Press to release the door
[5]	Talk/Mon button	<ul style="list-style-type: none"> <li>• Press to communicate hands free with visitor</li> <li>• Press to view the outdoor condition in standby mode</li> </ul>
[6]	MENU button	Press to display the menu
[7]	Microphone	Transmit audio from one station to other stations
[8]	Mounting hook	Use to hang up the monitor
[9]	Speaker	Send out sounds of ring tones, audios and alarms
[10]	Connection port	Bus terminal

## Mounting

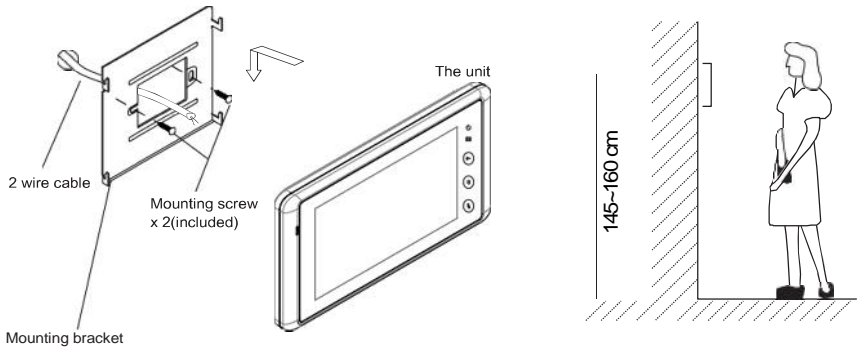

The installation height is suggested to 145~160cm.

1. Use screws to fasten the mounting bracket to the wall with mounting box.
2. Connect the 2 wire cables to the unit.
3. Mount the unit to the mounting bracket, make sure the unit is absolutely attached to the mounting bracket.

## Terminal description

**L1,L2:** Bus line terminal.

**SW+,SW-:** Extra door bell call button connection port.

**Ring,GND:** Extra buzzer connection port.

**NC:** Undefined.

**DIP switches:** Total 6 bits can be configured.

- **Bit1~Bit5:** User Code setting.
- **Bit6:** Set to **ON** if the monitor is at the end of the line or works with VSP804. Otherwise, set to **OFF**.

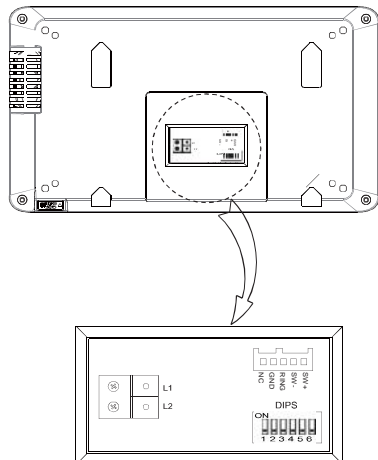

---

## Screen

### Main Menu

The Main menu is your starting point for using all the applications on your monitor. You can customize your Main menu to display your logo.

Touch anywhere of the screen on monitor in standby mode, the Main menu will appear as follow:

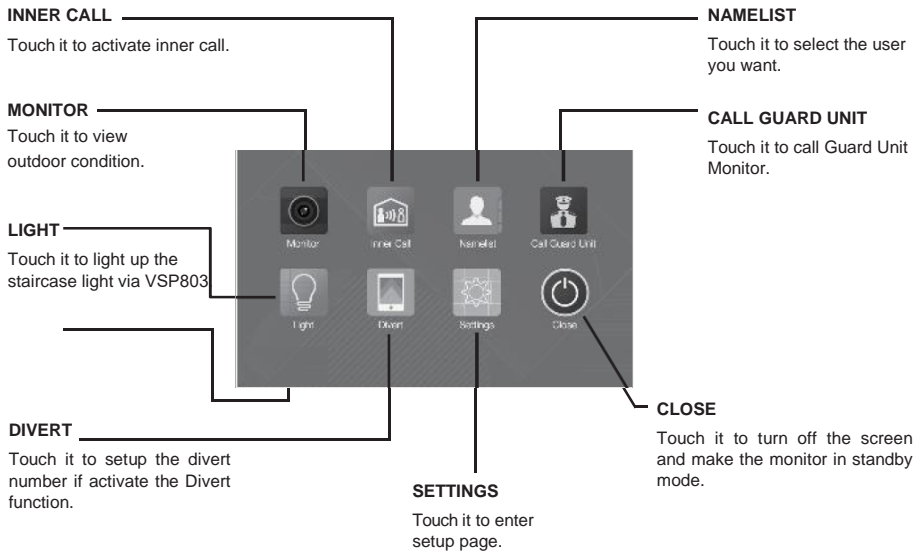

### While talking with a door station



Displays which door station is calling.

Displays talking time.

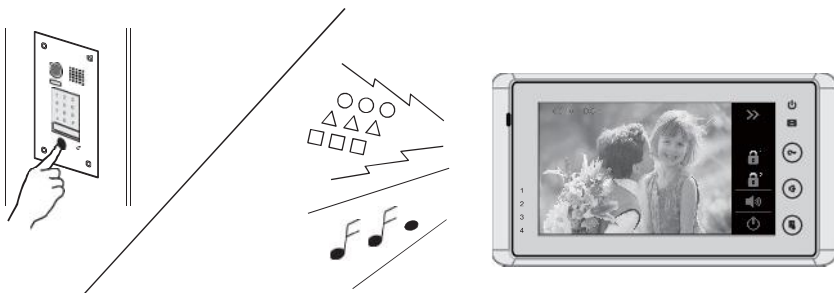

## Answering a call



- When there is a call from a video door station. The call tone sounds, an image will be displayed on the screen.
- Touch  icon on screen or press  **TALK/MON** button on the panel, begin communicating hands free with the visitor for 90 seconds.
- While communicating with the visitor, unlock the door, capture images/videos and adjust screen&volume are available. More details, please refer to the following descriptions.

**Note:** If nobody answers the phone, the screen will be turned off automatically after 40 seconds.

## Adjusting image scale while being called/talking

It's available to adjust image scale while being called. Total 2 image modes can be selected.

Follow the steps:



---

Compare the difference of these 2 image modes:



## To complete communication

- Touch  icon on screen or press the  **TALK/MON** button on the panel to complete the communication.

**Note:** Communication also ends automatically after 90 seconds.

### 1.Receiving a call while talking with a door station

- Other door stations calling is forbidden
- Conclude current talking to answer the new call-in

### 2.Receiving a call while talking with other monitors

- The talking will stop immediately, call tone sounds in normal.
- The video image from the door station is displayed on the screen, talking, unlock, capture images/videos, adjust screen & volume are available.



---

## Adjusting screen & volume

While receiving a call from door station, or monitoring /communicating with the visitor, you can adjust the screen and speaker volume. Follow the steps:



## Adjusting images

Total 4 scene modes can be selected in sequence: **Normal**, **Brightly**, **Soft** and **User**.

Whichever mode you choose, there will be a corresponding value for contrast, brightness and color.

You should know that the contrast, brightness and color can be modified freely, but this action should be at the **User** scene mode.



Adjust the contrast of the screen, the range is 0~9. Touch - or + to change the level.



Adjust the brightness of the screen, the range is 0~9. Touch - or + to change the level.



Adjust the color of the screen, the range is 0~9. Touch - or + to change the level.

**Note:** The adjustments have no effect on the recorded images.

## Adjusting the speaker volume

Volume can be adjusted at any time.



Adjusting range: 0 - 9.



Touch - or + to reach desired level.

## Door release

It is available to release the door during a call-in, communication, or while monitoring a door station.

Touch either  or  icon on the screen or press  **UNLOCK** button on panel to release door. The door lock is released for the set door release time.

(If two locks are connected to door station, touch  icon to release the second lock.)

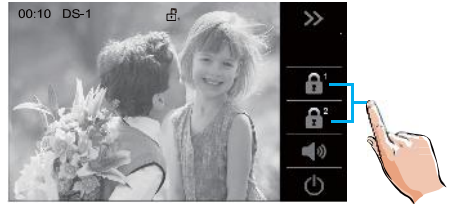



## Calling other monitors

It is available to call between monitors in the same room or in the same system, or call the Guard Monitor. Follow the steps to activate the functions:

### Calling monitors in the same room

Touch **[Inner Call]** icon on one of monitor, all other monitors in the same room will ring at the same time, whichever monitor answers the call, conversation is started, other monitors will stop ringing at once. (Calling ends automatically after 30 seconds if nobody answers the call)



\* Use "" or "" to adjust the microphone volume.

\* Touch  icon to end the calling.

---

## Calling other monitors in the same system

Touch **[Name list]** icon on monitor, the users in the same system will be displayed. Just select one target, touch  icon to call the corresponding user. If the call is answered, conversation is activated.

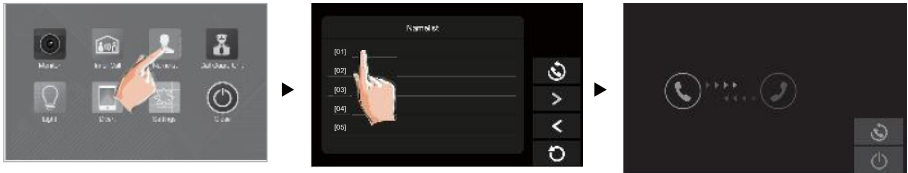

### Note:

- \* Use "<" or ">" to scroll pages.
- \* Touch  to redial when the icon is on the screen.
- \* Calling ends automatically after 40 seconds if nobody answers the call.

## Calling the guard monitor

A Monitor can be assigned as Guard Unit Monitor; when the Guard Unit Monitor answers the call, conversation with the guard person is started.

## Monitoring

You can monitor the entrance at any time via the monitor.

- 1.Touch anywhere of the screen or press the  **MENU** button on the panel in standby mode.
- 2.Touch **[MONITOR]** icon on main menu page to enter **Monitor select**page.

\*Note: Press  **TALK/MON** button on panel in standby mode to monitor the master door station in shortcut.

### Monitoring door stations/cameras:

- DS1~4 and CAM1~4 can be selected to monitor individually if the system installs multi door stations/cameras. See the following steps:

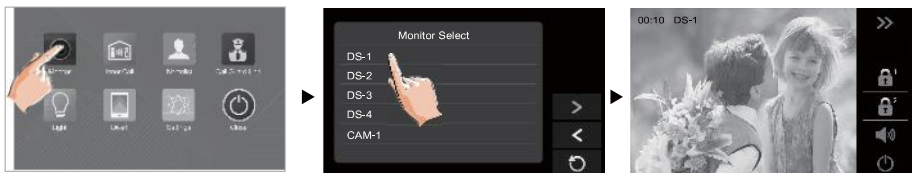

\* During monitoring, images can be viewed, but audio cannot be heard.

\* If there is a visitor at the entrance, touch  icon on screen to begin communication with door station.

---

## Opening staircase light

**Note:** The staircase light should be connected on the system, and this function should be supported by VSP 803. Please refer to VSP 803 user instruction in detail.

Touch **[Light]** icon on main menu page or touch  icon during monitoring or talking to open the staircase light, the staircase light will be turned off automatically after 60 seconds.

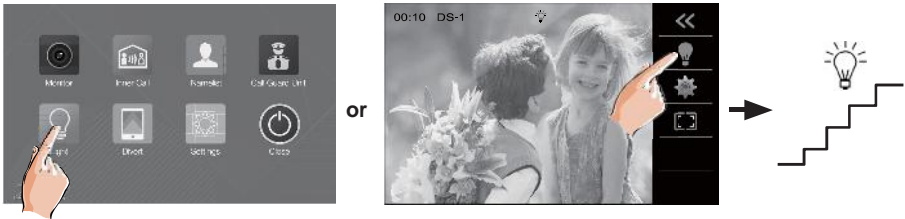

\*Touch **[Light]** icon again to turn off the light.

\*Touch  icon again to turn off the light.

---

## Monitor settings

You can set the quantity of door station and camera, monitor time at any time by following the procedure below.

1. On main menu page, touch **Settings** icon.

2. Select the item you want, then touch  $\oplus / \ominus$ , or  $\langle / \rangle$  icon to change the value.



**Note:**  icon to exit and return to main menu page.

## Ring setting

The ring call tone can be set individually to distinguish different calling sources.

1. On main menu page, touch **Settings** icon -> **Ring**.
2. Touch the setting target of door tone, intercom tone, doorbell tone and ring volume individually, then touch  $\oplus / \ominus$ , or  $\ominus / \oplus$  icon to change the value. Settings will perform immediately.



**Note:**  icon to exit and return to main menu page.

## Changing the display language

The default language can be customized. But you can change it to the language you need at any time. Follow the steps:

- On main menu page, touch **Settings** icon -> **Language**.
- Touch desired language and select  to save the setting.



\*If the target language is not found in the window, touch  $\ominus / \oplus$  icon to scroll next page.

## Restoring to default setting

The restore to default function allows the user to recover the settings to factory setting.

- On main menu page, touch **[Siera]** icon to enter **About** page.
- Touch  icon to restore to default.



## Entering installer setup

- On main menu page, touch **[Siera]** icon to enter **About** page.
- When the screen stay in **About** page, press  **UNLOCK** button on front panel and hold for 2 seconds.
- A keypad is shown.

Refer to the followings:



■ The setting items and codes are as followings

Code	Setting Item	Code	Setting Item
2412	Reset To Default Setting	8016-8017	Bypass Enable/Disable
2499	Restore Factory Settings	8401-8499	Unlock Time
8000	Master Monitor	8018-8020	Video Display Standard
8001~8003	Slave Monitor	9015-9016	Enable/Disable Intercom Call
8006-8007	Setting Slave Monitor Panel On/Off	9017-9018	Scale Mode 4:3/16:9
8010-8011	Unlock Mode: Close/Open		

■ Entering Address setting page

With a tool to Toggle one of the DIP to open **Address Setting** menu.

Refer to the followings:

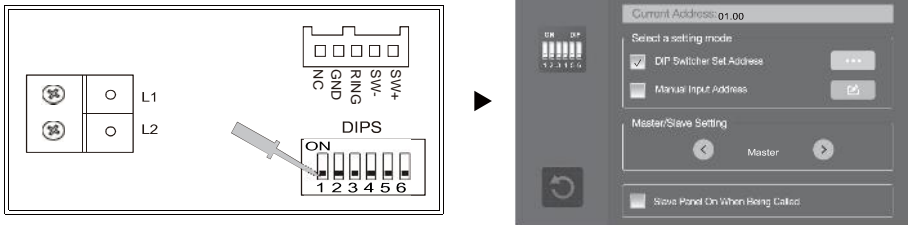

**Setting master/slave monitor**

Maximum 4 monitors can be connected in one apartment, one master monitor together with 3 slave monitors, so you should set the address correctly.(Note: must have one monitor to be set as a master monitor)

- Select Master/Slave Setting item, touch ⏪ / ⏩ icon to scroll to next item, settings will perform immediately.



---

## Setting slave monitor panel on

In default mode, when receiving a call, the master and slave monitors will ring at the same time, and just the master monitor can display the image while the slave monitors will not. But the settings can be changed, you can set the master monitor and the entire slave monitors to panel on at the same time when being called.

- Click “ Slave Panel On When Being Called” item, when “ ✓ “ symbol is displayed in the frame , the setting is activated.
- Click the item again to cancel.

## Setting user code

On 800 System, every apartment must assign a unique identification called **User Code**. There are two setting modes for address setting, DIP switcher and manual input.



### DIP Switcher Set Address

The DIP switches are used to set the user code for each monitor. Total 6 bits can be configured.

- Bit-1 to Bit-5 are used for user code setting. The value range is from 0 to 31, which have 32 different codes for 32 apartments.
- When multi monitors need to be installed in one apartment, these monitors should use the same user code, and the master/slave mode should be set on the monitor. (Details refer to the section of **Setting Slave Monitor**)
- Bit-6 is bus line terminal switch, which should be set to “ON” if the monitor is at the end of bus line, otherwise be set to “OFF”.

### Bit-6 switch setting



Bit state	Setting	Bit state	Setting
	When monitor is not at the end of bus line.		When monitor is at the end of bus line.

This monitor is assigned with DIP setting instructions.

On Address setting page, select DIP Switcher Set Address setting mode firstly, then touch , total 32 DIP codes will be displayed.

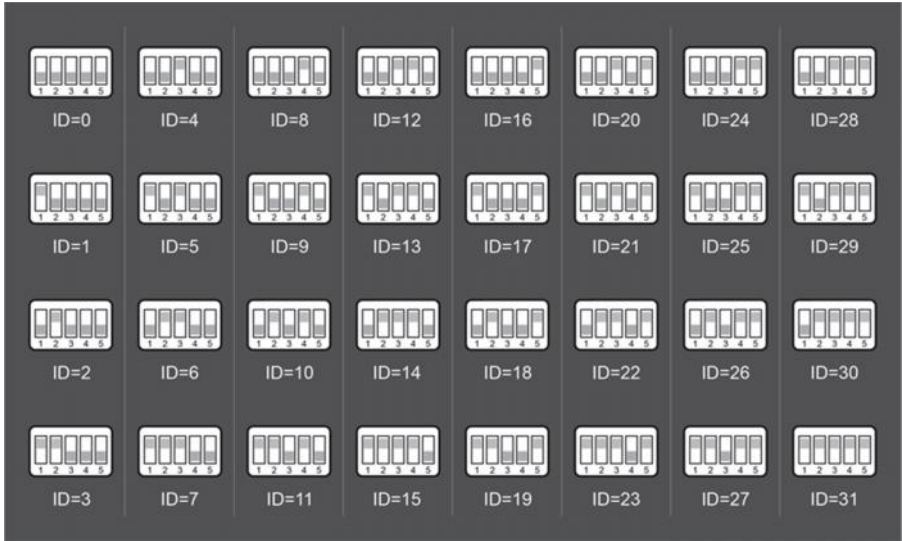

## Manual Input Address

It's available to input the address manually for this monitor.

- Total 32 numbers to be set, from 00~31.
- When multi monitors need to be installed in one apartment, these monitors should use the same user code, and the master/slave mode should be set on the monitor. (Details refer to the section of **Setting Slave Monitor**)

1. On Address setting page, select Manual Input Address setting mode, then touch  icon, a keypad will be displayed.

2. Input the code by touching the digital number.

3. Touch “#” key to save, code setting complete.

4. Touch “” key to delete.

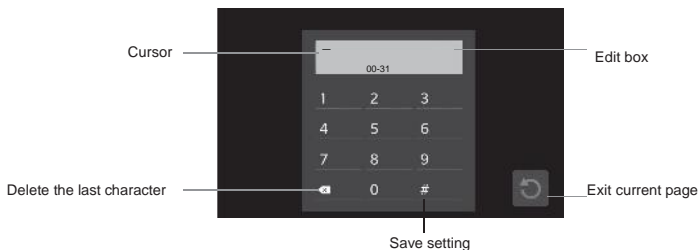

Save setting

---

## Screen Calibration

- In standby mode, press  **UNLOCK** button on front panel and hold for 3seconds.
- Screen calibration menu is shown.
- Click “+” to complete the calibration.

Refer to the followings:

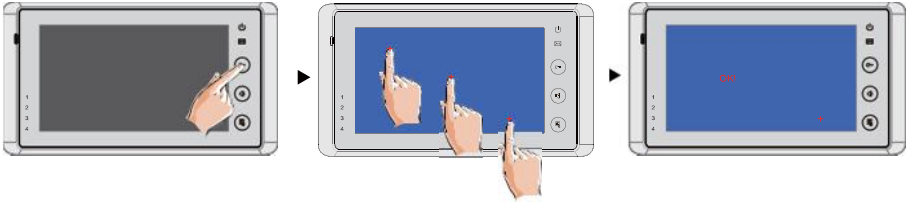

## Specification

Power supply for indoor monitor:	DC 24V
Power consumption:	Standby 15mA; Working 400mA
Monitor screen:	7 Inch digital color LCD
Display Resolutions:	800*3(R, G, B) x 480 pixels
Video signal:	1Vp-p, 75 , CCIR standard
Wiring:	2 wires, non-polarity
Dimension:	125(H)x225(W)x23(D)mm

