

ENGLISH

2 WIRE INTERCOM SYSTEM

USER MANUAL



Contents

1.Parts and Functions	1
2.Monitor Mounting	2
3.Main Menu	2
4.Basic Door Release Operation	2
5.Intercom Function	3
6.Basic Setup Instructions	3
7.Monitor Parameter Setting	5
8.Basic Connection	8
9.Specification	8
10.Precautions	9

1. Parts and Functions

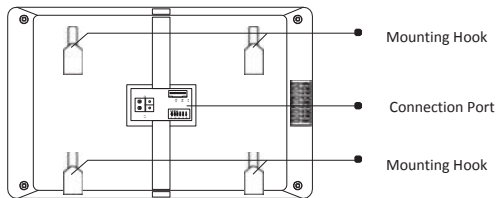
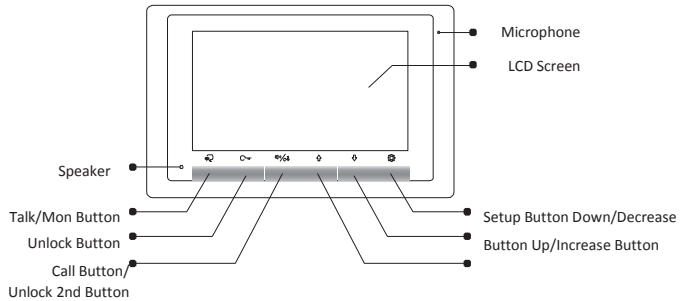

Key functions

Microphone	Receive voice from the user.
LCD screen	Display the visitors' image.
Setup button	Press to select the setting item you want.
Down/Decrease button	Press to decrease the value.
Up/Increase button	Press to increase the value.
Speaker	Send out voice from the visitor.
Talk/Mon button	Press to communicate hands free with visitor; Press to view the outdoor condition in standby mode.
Unlock button	Press to release the door
Call button/Unlock 2nd button	In standby mode, pick up handset, then press Call button to activate the inner call; During calling/talking state, press Unlock 2nd button to release the second door.
Mounting hook	Use to hang up the monitor.
Connection port	Bus terminal.

2. Monitor Mounting

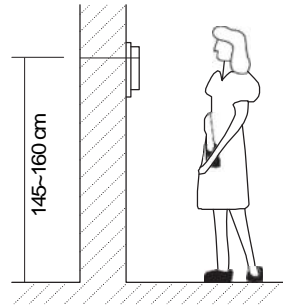
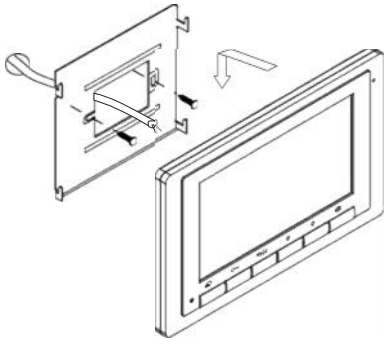

1. Use the screws to fix the Mounting Bracket on the mounting box (fitting accessories includes a Bracket (Two pieces of 4X25 screws are needed for fastening the Mounting Bracket), Special 2 wire connectors to connect with Monitor)
2. Wire the system correctly (see the later connection chapter) then hang the Monitor on the Mounting Bracket firmly.

3. Main Menu



Press **Setup** button, or Down/Decrease button, or Up/Increase button in standby mode, the main menu page will be shown as follows:



4. Basic Door Release Operation

1. Press **CALL** button on outdoor station, the Monitor rings, at the same time, the screen displays the visitors' image.
2. Press **TALK/MON** Button on monitor, you can communicate hands free with the visitor for 90 seconds. After finishing communication, press **TALK/MON** button again to end the communication. If nobody answers the phone, the screen will be turned off automatically after 40 seconds.



3. During talking state, Press **UNLOCK** Button to open the door for the visitor.(if two locks are connected to door camera, press  **unlock 2nd** Button to release the second lock)
4. When the monitor is in standby mode, press  **TALK/MON** Button, or press **Monitor** button on main menu, the screen can display the view of outside. At this time, if multi door stations are installed, you can use  Button to switch the door station or CCTV camera you want.

5. Intercom Function

Press **Intercom** button on main menu to get into the intercom mode.

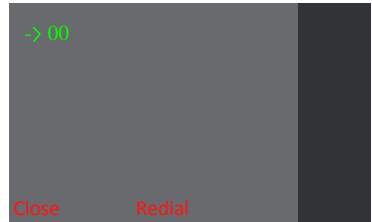

6. Basic Setup Instructions

Tone setting

Press **Setup** button on main menu page, then it will enter the setup page. You can set **Door Station Call Tone**, **Inercom Call Tone** or **DoorBell Tone** item on this page. Select the item you want, and then use  button to select the tone you want.

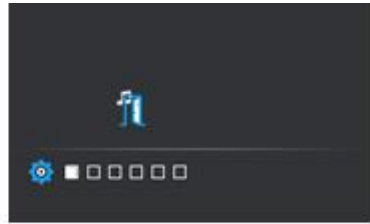

Tone volume setting

Press **Next** button to select the fourth item on setup page. And then use \uparrow / \downarrow button to increase/decrease the tone volume you want.

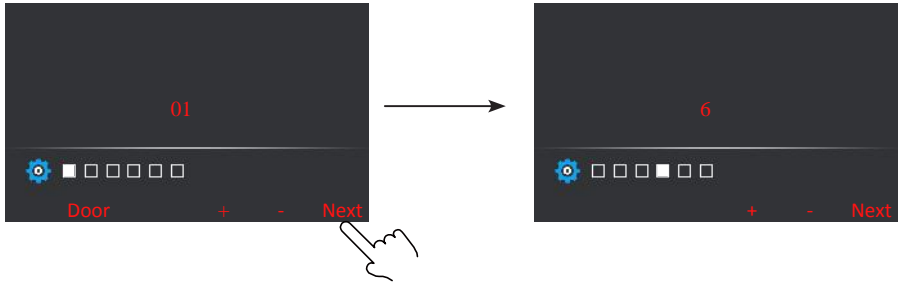

Restore to Default

Press **Next** button to select the fifth item on setup page. And then use \downarrow button to restore to default.

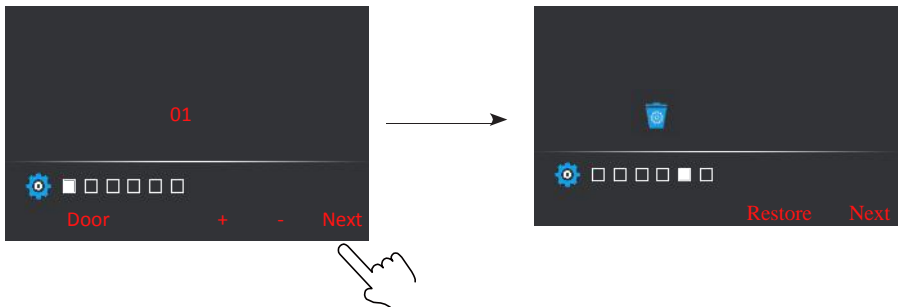

Screen and Volume Adjustment

1. During monitoring or talking state, press  **Setup** Button, the Adjust page will be displayed.
1. The Scene mode selection: Total 4 screen modes can be selected in sequence.

7. Monitor Parameter Setting

How to enter the installation setting page





1. Press **About** button on main menu page.

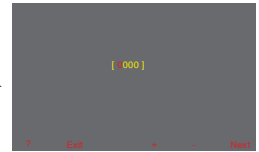

2. Press and hold  **UNLOCK** button for 3s.



3. Use  /  button to increase / decrease the value; use  button to select next digital.



How to know the machine code

When you want to set the monitor parameter, you must to know the setting code.

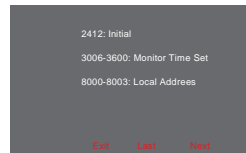

Press  button on this page.



Use  /  button to search the code you want.

How to set the slave monitor address

Maximum 4 monitors can be connected in one apartment, one master monitor together with 3 slave monitors, so you should set the address correctly (note: must have one monitor to be set as master monitor)

The code of 8000 is used to set the master monitor.

The code of 8001 is used to set the first slave monitor.

The code of 8002 is used to set the second slave monitor.

The code of 8003 is used to set the third slave monitor.

How to set date and time format

The system offers two methods of date and time.

The code number of 8008 is used to set the date format as month/date/year. The code number of 8009 is used to set the date format as date/month/year. The code number of 8012 is used to set the time format as 12 hour system. The code number of 8013 is used to set the time format as 24 hour system.

How to set the monitor panel on

In default mode, when receive a calling, the master and slave monitors will ring at the same time, and just the master monitor can display the image while the slave monitors cannot. But the settings can be changed, you can set the master monitor and all the slave monitors to panel on at the same time when receiving a call, just input the code number of 8006 on each slave monitor.



How to set the unlock parameter

Unlock mode:

There are two unlock modes: 1. power-on-to-unlock type: unlock mode=0 (by default)
2. power-off-to-unlock: unlock mode=1.

The code number of 8010 is used to set the unlock mode to 0. The code number of 8011 is used to set the unlock mode to 1.

Unlock time:

The unlock time can be changed by yourself at any time. It can be set from 1 to 9 seconds.

The code number from 8021 to 8029 are used to set the unlock time to 1~9 seconds.



How to set the user code for the monitor





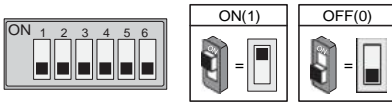



























In the VSP 827 system, every apartment must have a unique identification called User Code. The DIP switches are used to configure the User Code for each Monitor.

- Bit-1 to Bit-5 are used to User Code setting. The value is from 1 to 32, which have 32 different codes for 32 apartments.
- When multi Monitors are installed in one apartment, these Monitors have to use the same User Code setting, and the Master/Slave mode should be set on the Monitor.
- Bit-6 is line terminal switch, which have to be set to ON if the Monitor is in the end of the line(bus), otherwise set to OFF. The end of the line is terminal that no other section will start from it.

Bit-6 line terminal setting:



Bit state	Setting	Bit state	Setting
	Monitor not at the end of the line.		Monitor at the end of the line.

Bit state	User Code	Bit state	User Code	Bit state	User Code
	Code=1		Code=12		Code=23
	Code=2		Code=13		Code=24
	Code=3		Code=14		Code=25
	Code=4		Code=15		Code=26
	Code=5		Code=16		Code=27
	Code=6		Code=17		Code=28
	Code=7		Code=18		Code=29
	Code=8		Code=19		Code=30
	Code=9		Code=20		Code=31
	Code=10		Code=21		Code=32
	Code=11		Code=22		

8. Basic Connection

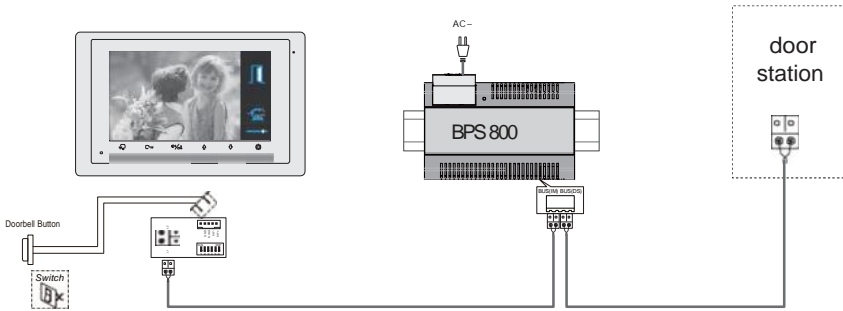

9. Specification

Power supply for indoor monitor:	DC 20~28V
Power consumption:	Standby 6.6mA; Working 240mA
Monitor screen:	7 Inch digital color LCD
Display Resolutions:	800*3(R, G, B) x 480 pixels
Video signal:	1Vp-p, 75Ω, CCIR standard
Wiring:	2 wires, non-polarity
● Dimension:	140(H)×220(W)×17.5(D)mm

10. Precautions

- 1) All components should be protected from violence vibration. And not allow to be impacted, knocked and dropped.
- 2) Please do the cleanness with soft cotton cloth, please do not use the organic impregnant or chemical clean agent. If necessary, please use a little pure water or dilute soap water to clean the dust.
- 3) Image distortion may occur if the video monitor is mounted too close to magnetic field e. g. Microwaves, TV, computer etc.
- 4) Please keep away the monitor from wet, high temperature, dust, caustic and oxidation gas in order to avoid any unpredictable damage.
- 5) Must use the right adaptor which is supplied by the manufacturer or approved by the manufacturer.
- 6) Pay attention to the high voltage inside the products, please refer service only to a trained and qualified professional.